

TECHNICAL DATA FOR REFERENCE ONLY!!

30793-9-0X-X3X

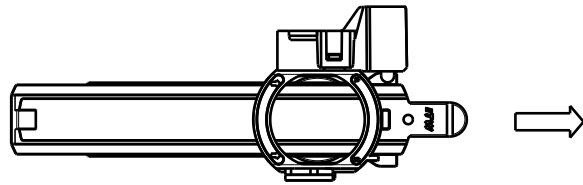

DIRECTION OF DAMPING

30794-9-0X-X3X

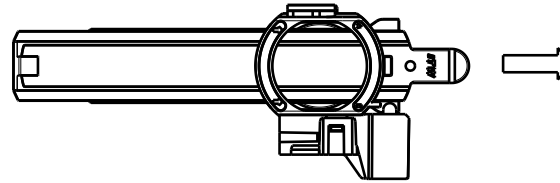

DIRECTION OF DAMPING

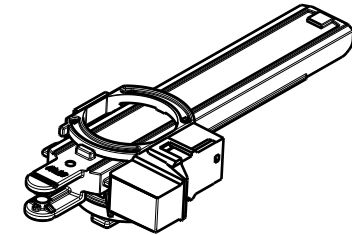

120.5

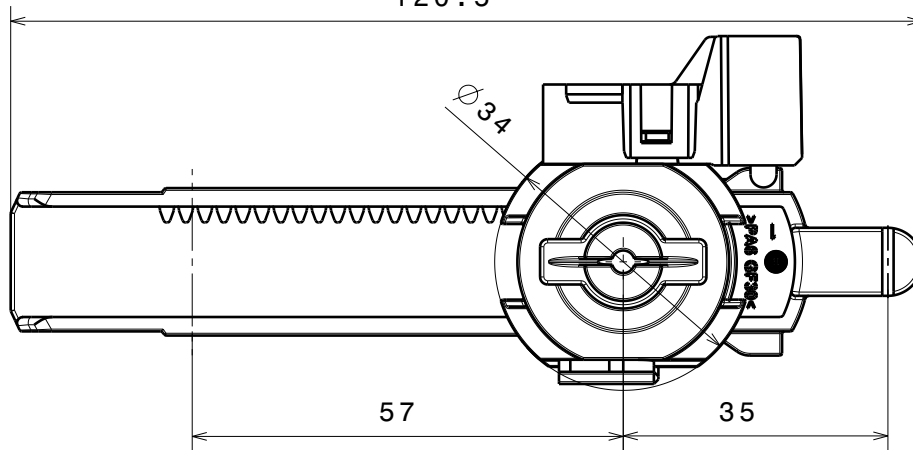

Note: Rack is available in different lengths upon request.

Torque at 23°C and 20 rpm	Torque ID
12.00 ± 2.00 Ncm	M
9.00 ± 1.50 Ncm	F
7.00 ± 1.20 Ncm	L
5.40 ± 0.90 Ncm	Z
4.00 ± 0.70 Ncm	E
3.00 ± 0.60 Ncm	S
2.40 ± 0.50 Ncm	C
2.20 ± 0.50 Ncm	Y

A-A

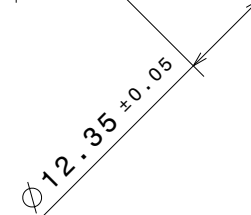
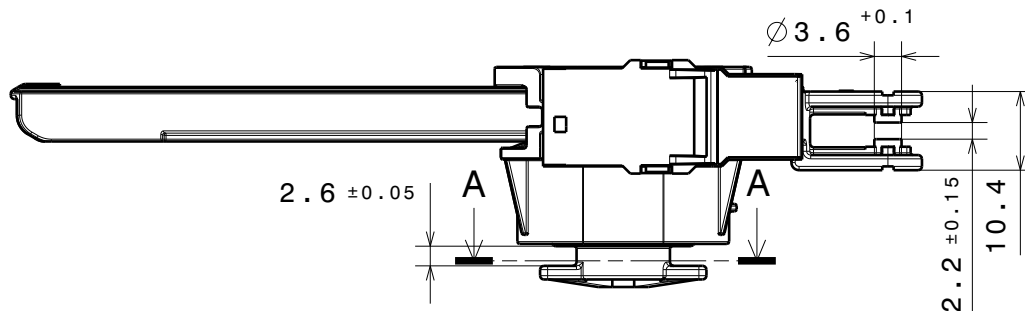
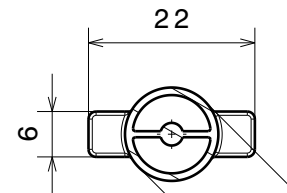

LINEAR DAMPER
1 way
30793/94
PART NO. 30793/94-9-0X-03X